

hyna

Workspace, Storage & Office Furniture 6.0



Introduction

"Design creates Culture. Culture shapes Values. Values determine the future."

KGR Fabtek a 30 year old fabrication Company conceptualizes the philosophy of sustainability in terms of design, and manufacturing modular furniture. HYNA is the brand name of KGR Fabtek. Our highly automated factory of 50,000 square feet is located in Chennai, Tamil Nadu, India. We are a family of 150 skilled and highly trained proficient manpower. We have state of the art technology and machinery in our factories. We take pride to state that our products are designed and manufactured under stringent quality checks. Customization is our forte. We meet all the requirements of our clients from design to installation.

Ongoing Innovation













Since it is ongoing, we remain committed to innovation and the constant search for new solutions to our customers requirement . Our engineers design, develop and thoroughly test every new solution to make sure it will work flawlessly in your facility.

Technical Expertise

Hyna's knowledge and technical expertise go beyond the products we sell. We understand best management practices, environmental concerns and the challenges that industrial facilities face every day. More than just a manufacturer of goods, we're here to help keep India's workplaces clean and safe.



INDEX

	SMALL PARTS STORAGE SYSTEM.....	04
	PHARMA +.....	11
	HIGH DENSITY STORAGE.....	13
	STORAGE CABINETS.....	15
	PERFORATED BOARD ACCESSORIES.....	24
	UTILITY TROLLEY.....	25
	UNIFLEX TROLLEY.....	26
	NC SYSTEMS.....	34
	HEXA WORKBENCH.....	41
	OFFICE CUPBOARDS.....	43
	STAFF LOCKER.....	48
	LIBRARY RACK.....	55

Small parts storage cabinets



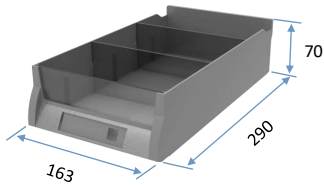

ART NO: J-70

Storage Cabinet

- 0.7mm CRCA formed sheet metal construction
- Completely knock down design
- 2 point locking mechanism with 2 keys
- Zero side edge design allows you to open the doors up to 180 degree
- 4mm toughened glass doors are available
- Epoxy polyester powder coated cabinet

Shelves

- Galvanized shelves
- Load capacity: 30 kg UDL / Shelf
- All shelves are height adjustable and removable

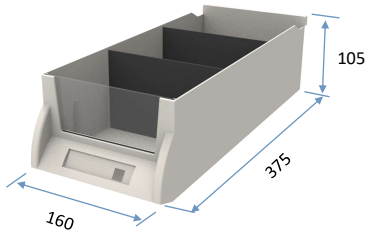

ART NO: J-105

Pull out bins

- Available in two different sizes (J-70 , J-105)
- Material: ABS (Acrylonitrile Butadiene Styrene)
- Transparent front plate: PS (Polystyrene)
- Supplied with 2 oartitions
- Max possible partition: 5 slots available
- Load capacity: (J-70 : 4 kg) (J-105: 6 kg)



MIDLEY - 1 880W x 376D x 1800H

No of Bins : 40 Nos
 Bottom compartment: Base + 1 shelf (Adjustable)
 4mm Toughened glass doors available

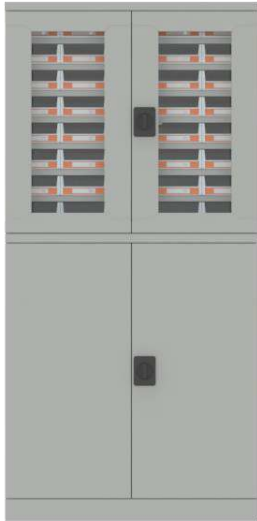
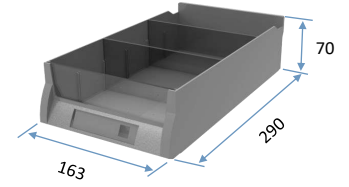

ART NO: M1-40 GS



ART NO: M1-40 SS

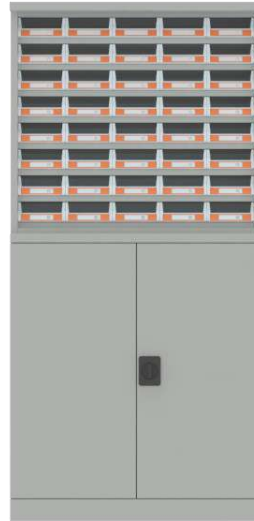

ART NO: M1-40 ES



ART NO: M1-40 EE

MIDLEY - 2 858W x 480D x 1800H

No of Bins : 30 Nos
 Bottom compartment: Base + 1 shelf (Adjustable)
 4mm Toughened glass doors available

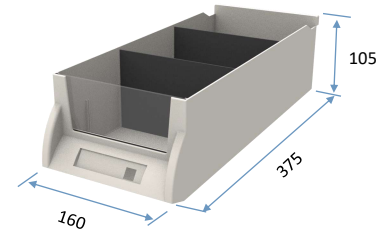

ART NO: M2-30 GS



ART NO: M2-30 SS



ART NO: M2-30 ES



ART NO: M2-30 EE

SIZE: 880W x 376D x 1800H

No of Bins : 90 Nos
4mm Toughened glass doors available

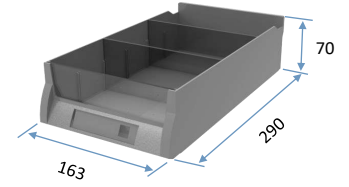

ART NO: LD-90 S

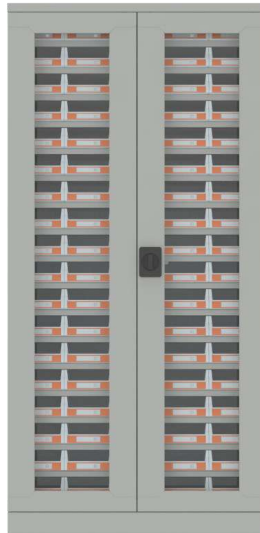

ART NO: LD-90 G

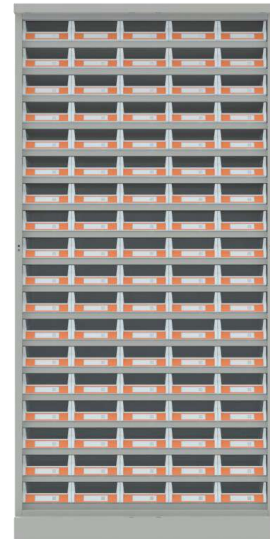

ART NO: LD-90 E

SIZE: 858W x 480D x 1790H

No of Bins : 65 Nos
4mm Toughened glass doors available

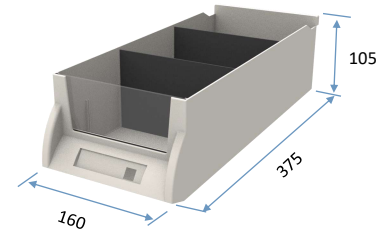

ART NO: HD-65 S



ART NO: HD-65 G

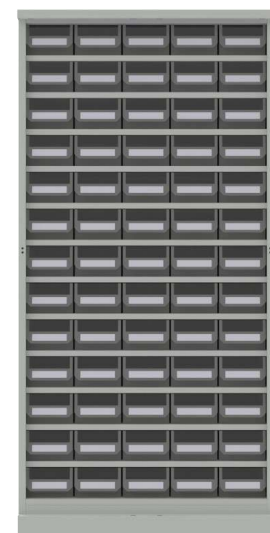

ART NO: HD-65 E

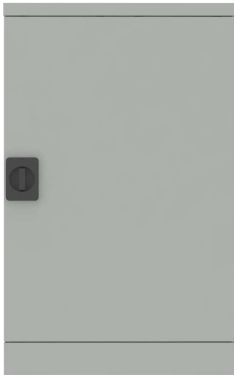

ART NO: LD-24 S
550W x 376D x 880H

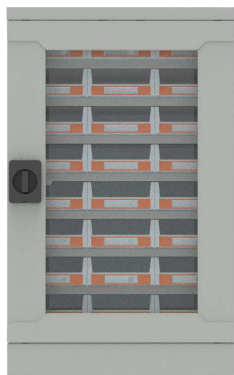

ART NO: LD-24 G
550W x 376D x 880H

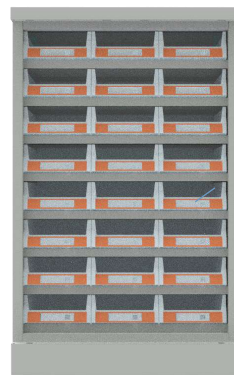

ART NO: LD-24 E
550W x 376D x 880H

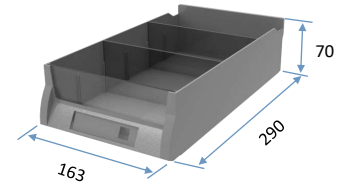

ART NO: LD-24 S/G/E
 S - Steel door
 G - Glass door
 E - Without door

Bin QTY ←

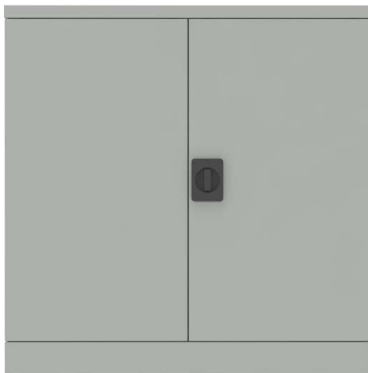

ART NO: LD-40 S
880W x 376D x 880H



ART NO: LD-40 G
880W x 376D x 880H

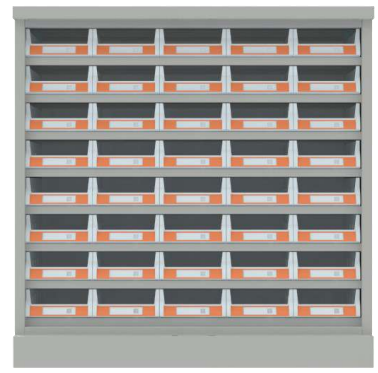

ART NO: LD-40 E
880W x 376D x 880H



ART NO: LD-60 S
880W x 376D x 1248H



ART NO: LD-60 G
880W x 376D x 1248H

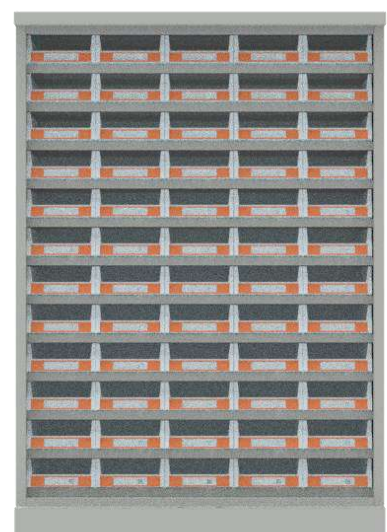

ART NO: LD-60 E
880W x 376D x 1248H

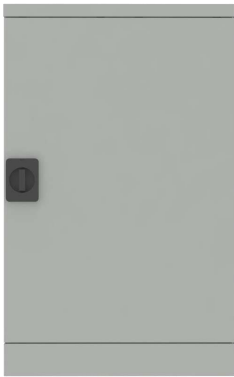

ART NO: HD-18 S
538W x 480D x 900H



ART NO: HD-18 G
538W x 480D x 900H



ART NO: HD-18 E
538W x 480D x 900H

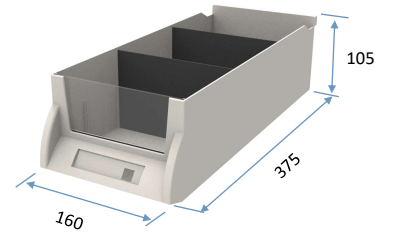

ART NO: HD-18 S/G/E
Bin QTY ← S - Steel door
G - Glass door
E - Without door

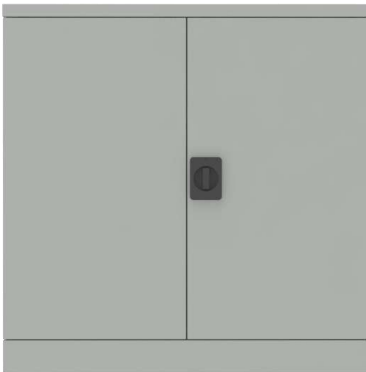

ART NO: HD-30 S
858W x 480D x 900H



ART NO: HD-30 G
858W x 480D x 900H

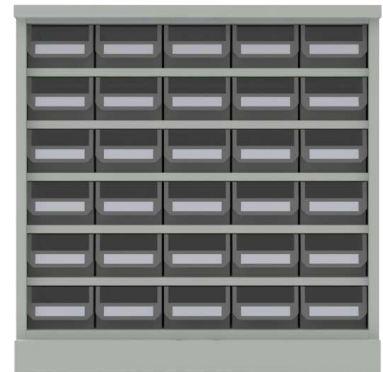

ART NO: HD-30 E
858W x 480D x 900H



ART NO: HD-45 S
858W x 480D x 1280H



ART NO: HD-45 G
858W x 480D x 1280H

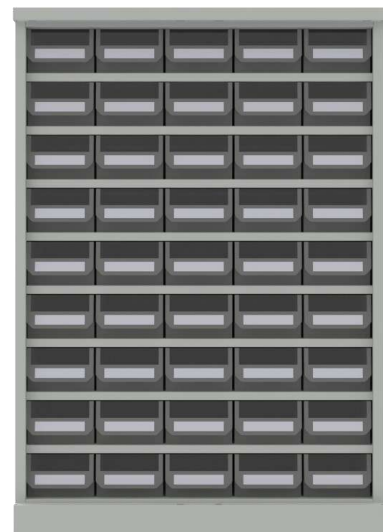

ART NO: HD-45 E
858W x 480D x 1280H



ART NO	DESCRIPTION	DIM	FINISH	SUITABLE FOR
ST-LDC5	STAND LDC5	W880 D376 H125	RAL 7035	M1-40, LD-90, LD-60, LD-40
ST-HDC5	STAND HDC5	W858 D480 H125	RAL 7035	M2-30, HD-65, HD-45, HD-30

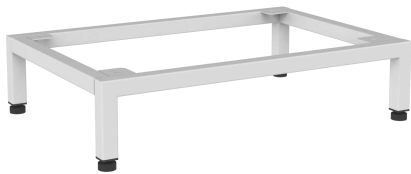

ART NO	DESCRIPTION	DIM	FINISH	SUITABLE FOR
ST-LDC3	STAND LDC3	W550 D376 H125	RAL 7035	LD-24
ST-HDC3	STAND HDC3	W538 D480 H125	RAL 7035	HD-18

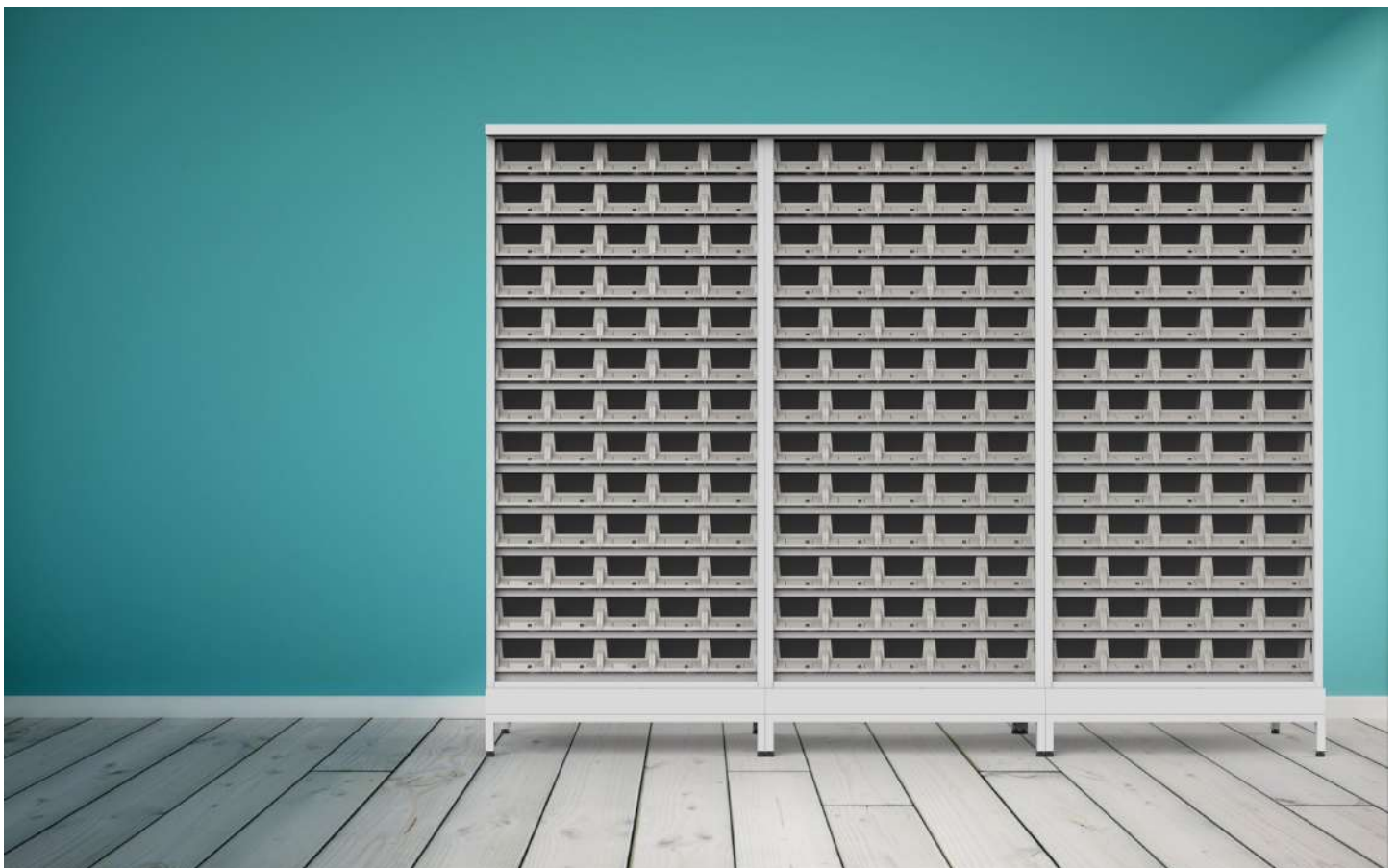

PHARMA +

hyna



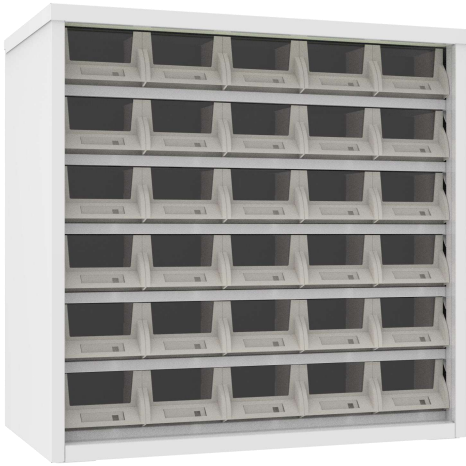

PH-30

W857 D472 H825 mm
Bin Art no: J-105
BIN QTY - 30 Nos
Bins supplied with 2 partitions
Galvanized shelves - 30 Kg UDL

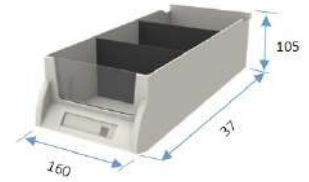

PH-SL09

W857 D472 H850 mm
Height adjustable shelves - 2 nos



PH-ST

W855 D472 H125 mm

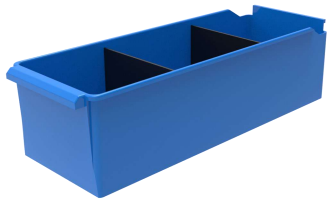

Blue bin

ART NO: HD 403-B

- Outer Dim: W146 D415 H110 mm
- Effective height: 105mm
- Colour : Bin - Blue, Partition - Black



ESD Bin

ART NO: HD 403-ESD



- Outer Dim: W146 D415 H110 mm
- Effective height: 105mm
- Made from conductive poly propylene



Transparent Bin

ART NO: HD 403-T

- Outer Dim: W146 D415 H110 mm
- Effective height: 105mm
- Colour : Bin & Partition - Transparent

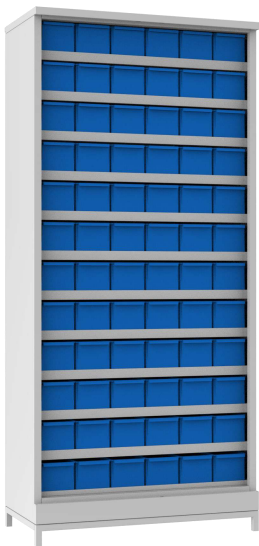

HDSC-B-72 E

W960 D470 H2100 mm
Bin Art no: HD 403-B
BIN QTY - 72 Nos
Bins supplied with 2 partitions
Galvanized shelves - 60 Kg UDL

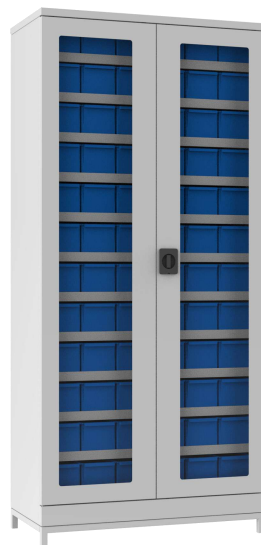

HDSC-B-72 G

W960 D470 H2100 mm
Bin Art no: HD 403-B
BIN QTY - 72 Nos
Bins supplied with 2 partitions
Galvanized shelves - 60 Kg UDL



HDSC-B-72 S

W960 D470 H2100 mm
Bin Art no: HD 403-B
BIN QTY - 72 Nos
Bins supplied with 2 partitions
Galvanized shelves - 60 Kg UDL



HDSC-ESD-72 E

W960 D470 H2100 mm
 Bin Art no: HD 403-ESD
 BIN QTY - 72 Nos
 Bins supplied with 2 partitions
 Galvanized shelves - 60 Kg UDL



HDSC-ESD-72 G

W960 D470 H2100 mm
 Bin Art no: HD 403-ESD
 BIN QTY - 72 Nos
 Bins supplied with 2 partitions
 Galvanized shelves - 60 Kg UDL



HDSC-ESD-72 S

W960 D470 H2100 mm
 Bin Art no: HD 403-ESD
 BIN QTY - 72 Nos
 Bins supplied with 2 partitions
 Galvanized shelves - 60 Kg UDL



HDSC-T-72 E

W960 D470 H2100 mm
 Bin Art no: HD 403-T
 BIN QTY - 72 Nos
 Bins supplied with 2 partitions
 Galvanized shelves - 60 Kg UDL



HDSC-T-72 G

W960 D470 H2100 mm
 Bin Art no: HD 403-T
 BIN QTY - 72 Nos
 Bins supplied with 2 partitions
 Galvanized shelves - 60 Kg UDL











HDSC-T-72 S

W960 D470 H2100 mm
 Bin Art no: HD 403-T
 BIN QTY - 72 Nos
 Bins supplied with 2 partitions
 Galvanized shelves - 60 Kg UDL

hyna

STORAGE CABINETS



	ART NO	OD	EFFECTIVE HT
	BS 05	168(L) x 102 (W) x 74(H)	38
	BS 15	201(L) x 125 (W) x 101(H)	48
	BS 25	229(L) x 150 (W) x 126 (H)	58
	BS 35	300(L) x 208 (W) x 158 (H)	80
	BS 45	348(L) x 210 (W) x 200 (H)	110
	BK 32	300(L) x 140 (W) x 140 (H)	65
	BK 33	300(L) x 215 (W) x 140 (H)	65
	BK 35	300(L) x 435 (W) x 140 (H)	65

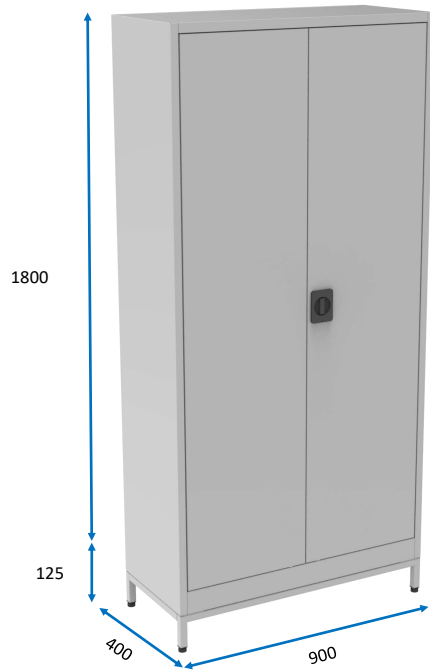

Storage Cabinet

- 0.7mm CRCA formed sheet metal construction
- Completely knock down design
- 2 point locking mechanism with 2 keys
- Shelves load capacity : 90kg UDL & 50 kg UDL
- 4mm toughened glass doors are available
- Epoxy polyester powder coated cabinet
- Galvanized shelves



SC-E
W900 D400 H1925 mm
GI Shelves -90 kg UDL



SC-G
W900 D400 H1925 mm
GI Shelves -90 kg UDL



SC-S
W900 D400 H1925 mm
GI Shelves -90 kg UDL



PBC1-E
W900 D400 H1925 mm
GI Shelves -90 kg UDL
BS 45 - 12 Nos



PBC1-G
W900 D400 H1925 mm
GI Shelves -90 kg UDL
BS 45 - 12 Nos



PBC1-S
W900 D400 H1925 mm
GI Shelves -90 kg UDL
BS 45 - 12 Nos



PBC2-E
W900 D400 H1925 mm
GI Shelves -90 kg UDL
BK 32 - 24 Nos



PBC2-G
W900 D400 H1925 mm
GI Shelves -90 kg UDL
BK 32 - 24 Nos



PBC2-S
W900 D400 H1925 mm
GI Shelves -90 kg UDL
BK 32 - 24 Nos



BS1-E
 W900 D400 H1925 mm
 GI Shelves -90 kg UDL
 BS 45 - 24 Nos



BS1-G
 W900 D400 H1925 mm
 GI Shelves -90 kg UDL
 BS 45 - 24 Nos



BS1-S
 W900 D400 H1925 mm
 GI Shelves -90 kg UDL
 BS 45 - 24 Nos



BS2-E
 W900 D400 H1925 mm
 GI Shelves -90 kg UDL
 BK 32 - 48 Nos



BS2-G
 W900 D400 H1925 mm
 GI Shelves -90 kg UDL
 BK 32 - 48 Nos



BS2-S
 W900 D400 H1925 mm
 GI Shelves -90 kg UDL
 BK 32 - 48 Nos



BSC1-E

W900 D400 H1925 mm
 GI Shelves -90 kg UDL
 BK 32 - 24 Nos
 BS 45 - 12 Nos



BSC1-G

W900 D400 H1925 mm
 GI Shelves -90 kg UDL
 BK 32 - 24 Nos
 BS 45 - 12 Nos



BSC1-S

W900 D400 H1925 mm
 GI Shelves -90 kg UDL
 BK 32 - 24 Nos
 BS 45 - 12 Nos



BSC2-E

W900 D400 H1925 mm
 GI Shelves -90 kg UDL
 BK 32 - 18 Nos
 BK33 - 12 Nos
 BK35 - 4 Nos



BSC2-G

W900 D400 H1925 mm
 GI Shelves -90 kg UDL
 BK 32 - 18 Nos
 BK33 - 12 Nos
 BK35 - 4 Nos



BSC2-S

W900 D400 H1925 mm
 GI Shelves -90 kg UDL
 BK 32 - 18 Nos
 BK33 - 12 Nos
 BK35 - 4 Nos



RC1-E

W900 D400 H1925 mm
 GI Shelves -90 kg UDL
 Bin rail - 15 kg UDL
 Bs 05 - 32 Nos
 BS 15 - 21 Nos
 BS 45 - 12 Nos



RC1-G

W900 D400 H1925 mm
 GI Shelves -90 kg UDL
 Bin rail - 15 kg UDL
 Bs 05 - 32 Nos
 BS 15 - 21 Nos
 BS 45 - 12 Nos



RC1-S

W900 D400 H1925 mm
 GI Shelves -90 kg UDL
 Bin rail - 15 kg UDL
 Bs 05 - 32 Nos
 BS 15 - 21 Nos
 BS 45 - 12 Nos



RC2-E

W900 D400 H1925 mm
 GI Shelves -90 kg UDL
 Bin rail - 15 kg UDL
 Bs 05 - 32 Nos
 BS 15 - 21 Nos
 BK 32 - 24 Nos



RC2-G

W900 D400 H1925 mm
 GI Shelves -90 kg UDL
 Bin rail - 15 kg UDL
 Bs 05 - 32 Nos
 BS 15 - 21 Nos
 BK 32 - 24 Nos



RC2-S

W900 D400 H1925 mm
 GI Shelves -90 kg UDL
 Bin rail - 15 kg UDL
 Bs 05 - 32 Nos
 BS 15 - 21 Nos
 BK 32 - 24 Nos

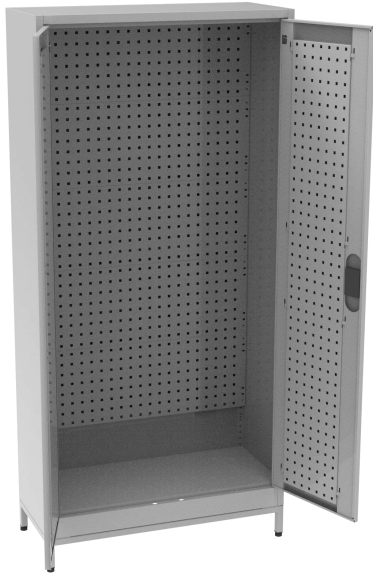

MPC-01
W900 D400 H1925 mm



MPC-02
W900 D400 H1925 mm
GI Shelves -90 kg UDL



MPC-03
W900 D400 H1925 mm
GI Shelves -90 kg UDL



MPC-04
W900 D400 H1925 mm
GI Shelves -90 kg UDL
100mm Drawer -3 Nos (35 kg UDL)
Effective Height - 70mm



MPC-05
W900 D400 H1925 mm
GI Shelves -90 kg UDL
100mm Drawer -3 Nos (35 kg UDL)
Effective Height - 70mm



MPC-06
W900 D400 H1925 mm
GI Shelves -90 kg UDL
100mm Drawer -3 Nos (35 kg UDL)
Effective Height - 70mm



Empty cabinet

ART NO	DIM	Cabinet capacity
SC - EC	W900 H1925 D400 mm	800 kg

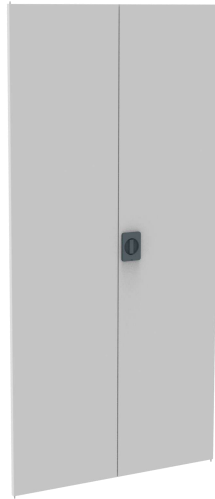

Pair of steel doors

ART NO	LOCK
SC - SD	2 POINT LOCK WITH 2 KEYS

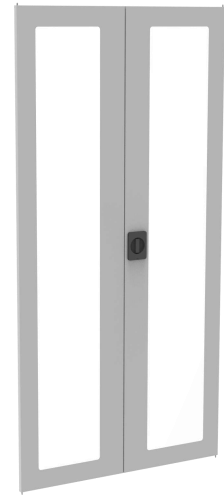

Pair of glass doors

ART NO	LOCK
SC - GD	2 POINT LOCK WITH 2 KEYS

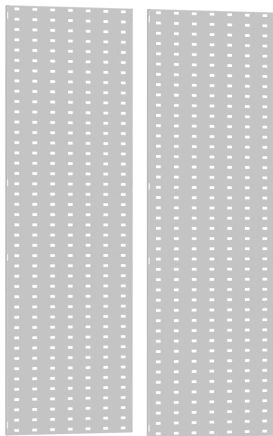

Pair of Door perforation panel

ART NO	CAPACITY
SC - DP	10 kg Each

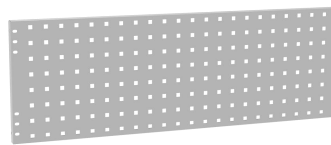

Back perforation panel

ART NO	CAPACITY
SC - BP	25 kg UDL



Adjustable shelf

ART NO	DETAILS
SC - SH90-PC	POWDER COATED SHELF - 90 kg
SC - SH90-GI	GALVANIZED SHELF - 90 kg



Shelf divider

ART NO	HEIGHT
SC - DV	250mm



Drawer cabinet

ART NO	HEIGHT X QTY	CAPACITY
SC - DR	100 mm X 3 Nos Effective height: 70mm	35 kg UDL Each drawer

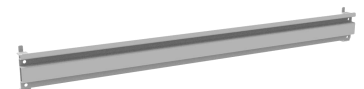

Bin rail

ART NO	CAPACITY
SC - BR	15 kg UDL



All indicated loads are net and refer to evenly distributed weights

Plastic Hooks



PBA-P-01
Hook 25mm

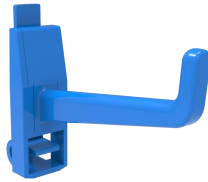

PBA-P-02
Hook 50mm



PBA-P-03
Screw driver Hook



PBA-P-04
Wrench holder

Steel Hooks



PBA-S-01
Suspension hook



PBA-S-02
Universal hook



PBA-S-03
Double hook



PBA-S-04
Plier hook



PBA-S-05
Closed hook

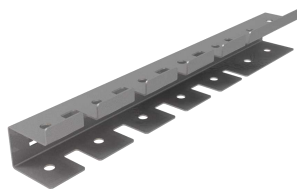

PBA-S-06
Screw driver holder

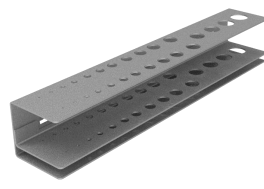

PBA-S-07
Drill bit holder

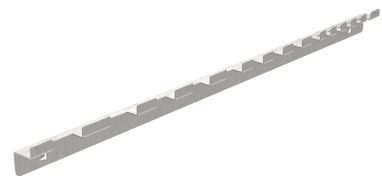

PBA-S-08
Wrench holder



UT-02

Overall dim. W1110 D615 H970 mm
Panel dim. W1005 D605 H60mm
Load capacity - 100 Kg / Shelf
100mm PU Wheels with brake



UT-03

Overall dim. W1110 D615 H970 mm
Panel dim. W1005 D605 H60mm
Load capacity - 100 Kg / Shelf
100mm PU Wheels with brake



UT-R

Rubber mat
Dim. W1000 D600 T3 mm



All indicated loads are net and refer to evenly distributed weights



hyna

UniFlex Trolley





Single face trolley



Double face trolley

Accessories

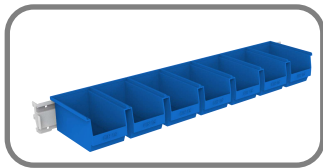

Universal bin rail



Tiltable shelf

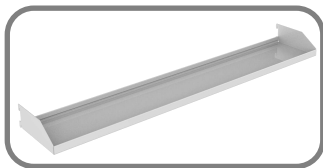

Fixed shelf

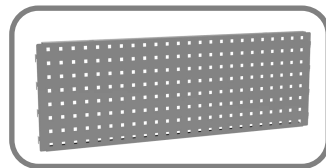

Perforation panel

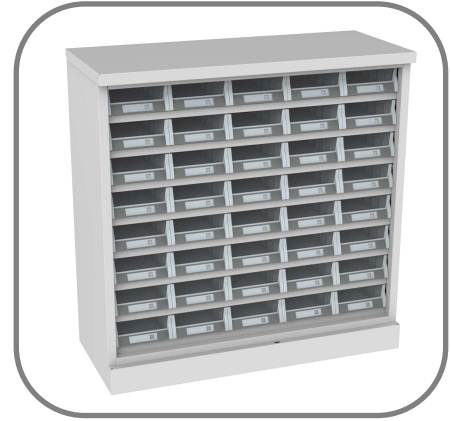

LD-40 BIN CABINET



All indicated loads are net and refer to evenly distributed weights

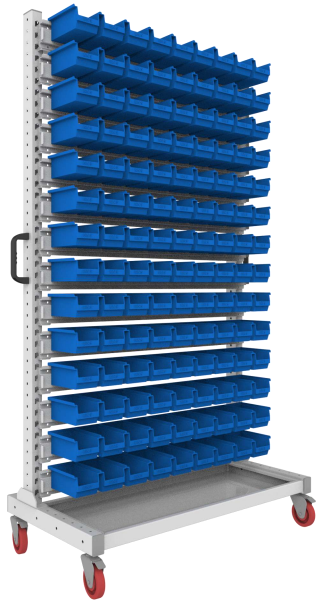

UF-SF-BS 05

W1000 H1835 D535 mm
BS 05 - 126 Nos

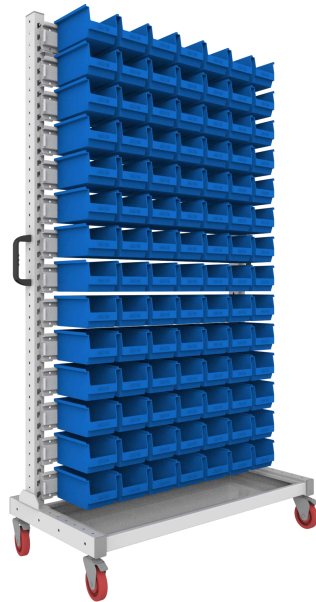

UF-SF-BS 15

W1000 H1835 D535 mm
BS 15 - 98 Nos

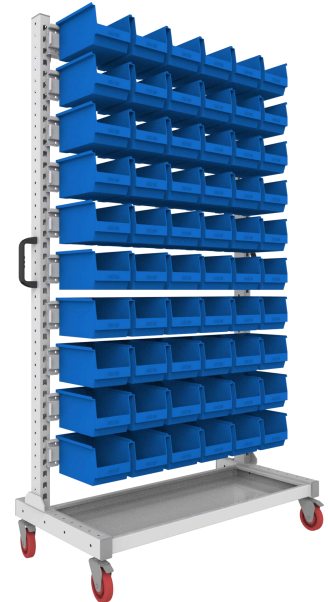

UF-SF-BS 25

W1000 H1835 D535 mm
BS 25 - 60 Nos

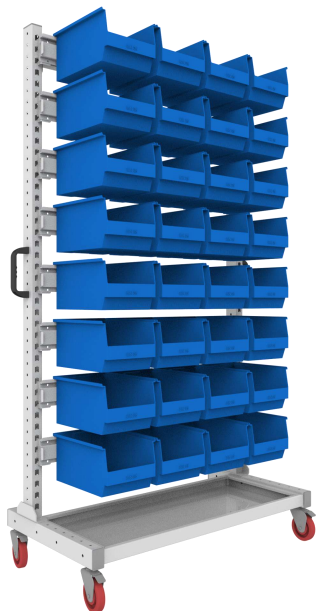

UF-SF-BS 35

W1000 H1835 D535 mm
BS 35 - 32 Nos

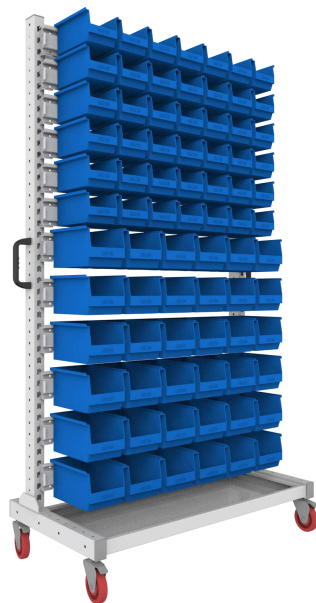

UF-SF-C1

W1000 H1835 D810 mm
BS 15 - 42 Nos
BS 25 - 36 Nos

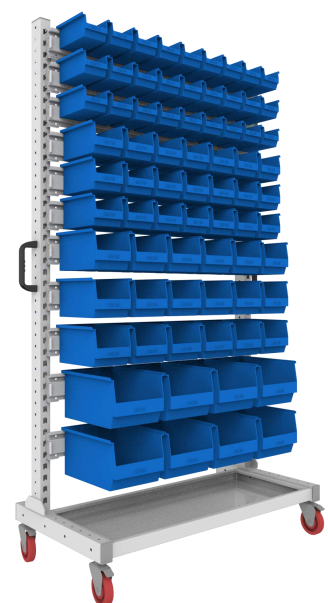

UF-SF-C2

W1000 H1835 D810 mm
BS 05 - 27 Nos
BS 15 - 21 Nos
BS 25 - 18 Nos
BS 35 - 8 Nos

- SF Trolley capacity - 150 kg UDL
- Bin rail capacity - 20 kg UDL

□ Refer page No. 16 for bin sizes



All indicated loads are net and refer to evenly distributed weights

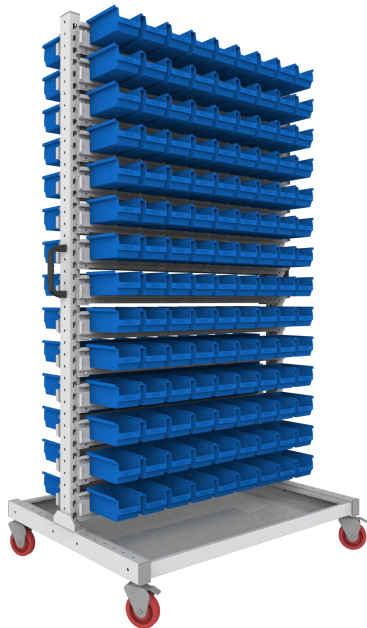

UF-Df-BS 05

W1000 H1835 D810 mm
BS 05 - 252 Nos



UF-Df-BS 15

W1000 H1835 D810 mm
BS 15 - 196 Nos

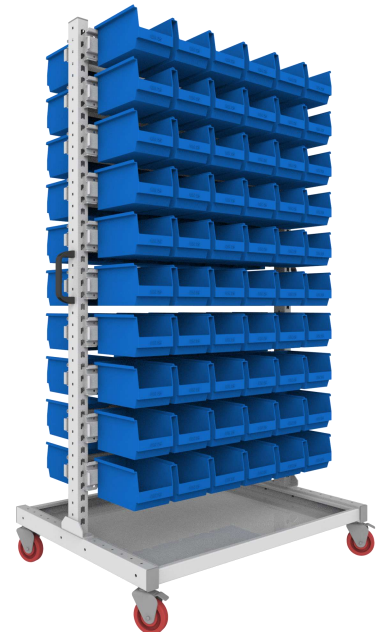

UF-Df-BS 25

W1000 H1835 D810 mm
BS 25 - 120 Nos



UF-Df-BS 35

W1000 H1835 D810 mm
BS 35 - 64 Nos



UF-Df-C1

W1000 H1835 D810 mm
BS 15 - 84 Nos
BS 25 - 72 Nos



UF-Df-C2

W1000 H1835 D810 mm
BS 05 - 54 Nos
BS 15 - 42 Nos
BS 25 - 36 Nos
BS 35 - 16 Nos

- DF Trolley capacity - 150 kg / Side UDL
- Bin rail capacity - 20 kg UDL

□ Refer page No. 16 for bin sizes



All indicated loads are net and refer to evenly distributed weights



UF-SF-SH 01

W1000 H1835 D535 mm
 Perforated panel H300 mm - 2 Nos
 Tilttable shelf D225 mm - 2 Nos
 Tilttable shelf D325 mm - 1 No



UF-SF-SH 02

W1000 H1835 D535 mm
 Perforated panel H300 mm - 2 Nos
 Tilttable shelf D225 mm - 3 Nos | BS 25 - 18 Nos
 Tilttable shelf D325 mm - 2 Nos | BS 35 - 8 Nos



UF-SF-SH 03

W1000 H1835 D535 mm
 Fixed shelf D165 mm - 3 Nos | BS 05 - 27 Nos
 Fixed shelf D225 mm - 3 Nos | BS 15 - 21 Nos
 Tilttable shelf D225 mm - 3 Nos | BS 25 - 18 Nos
 Tilttable shelf D325 mm - 2 Nos | BS 35 - 8 Nos



UF-DF-SH 01

W1000 H1835 D810 mm
 Perforated panel H300 mm - 4 Nos
 Tilttable shelf D225 mm - 4 Nos
 Tilttable shelf D325 mm - 2 No

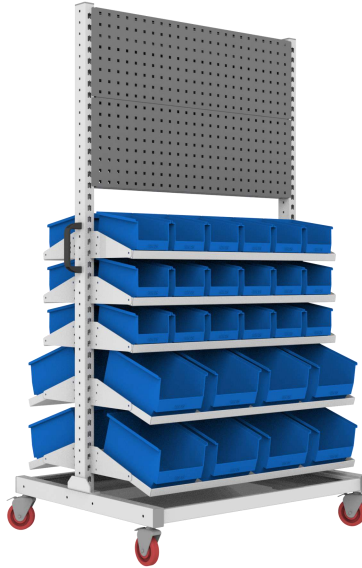

UF-DF-SH 02

W1000 H1835 D810 mm
 Perforated panel H300 mm - 4 Nos
 Tilttable shelf D225 mm - 6 Nos | BS 25 - 36 Nos
 Tilttable shelf D325 mm - 4 Nos | BS 35 - 16 Nos



UF-DF-SH 03

W1000 H1835 D810 mm
 Fixed shelf D165 mm - 6 Nos | BS 05 - 54 Nos
 Fixed shelf D225 mm - 6 Nos | BS 15 - 42 Nos
 Tilttable shelf D225 mm - 6 Nos | BS 25 - 36 Nos

- SF Trolley capacity - 150 kg
- DF Trolley capacity - 150 kg / Side
- Perforated panel - 20 kg UDL each
- Fixed shelf - 20 kg UDL each
- Tilttable shelf - 25 kg UDL each

□ Refer page No. 16 for bin sizes



All indicated loads are net and refer to evenly distributed weights

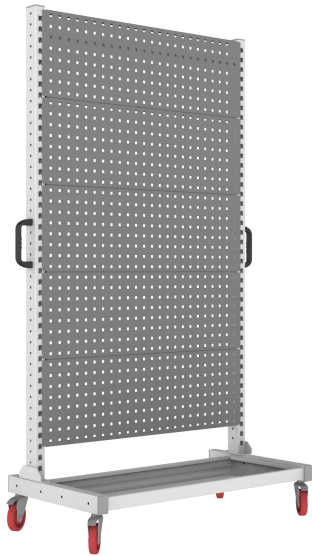

UF-SF-CS 01

W1000 H1835 D535 mm
Perforation panel H300 mm - 5 Nos



UF-SF-CS 02

W1000 H1835 D535 mm
Perforation panel H300 mm - 3 Nos
Tilttable shelf D225 mm - 1 No
Tilttable shelf D325 mm - 1 No



UF-SF-CS-LD40-E

W1000 H1835 D535 mm
Perforation panel H300 mm - 2 Nos
Small parts cabinet **LD-40** - 1 No (Ref. Page no: 8)
Add G - Glass door, S - Steel door

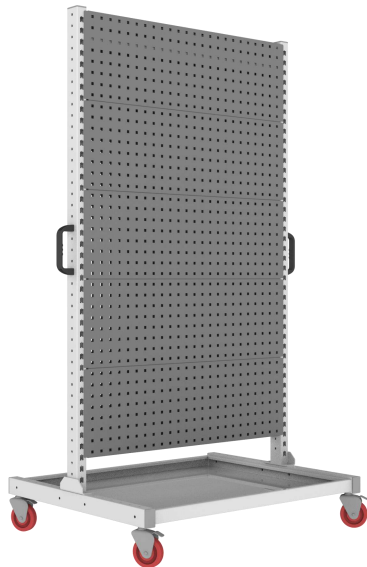

UF-DF-CS 01

W1000 H1835 D810 mm
Perforation panel H300 mm - 10 Nos



UF-DF-CS 02

W1000 H1835 D810 mm
Perforation panel H300 mm - 6 Nos
Tilttable shelf D225 mm - 2 Nos
Tilttable shelf D325 mm - 2 Nos



UF-DF-CS-LD40-E

W1000 H1835 D810 mm
Perforation panel H300 mm - 4 Nos
Small parts cabinet **LD-40** - 2 Nos (Ref. Page no: 8)
Add G - Glass door, S - Steel door

- ▣ SF Trolley capacity - 150 kg
- ▣ DF Trolley capacity - 150 kg / Side
- ▣ Perforated panel - 20 kg UDL each
- ▣ Tilttable shelf - 25 kg UDL each

▣ Refer page No. 24 for Hooks & accessories



All indicated loads are net and refer to evenly distributed weights

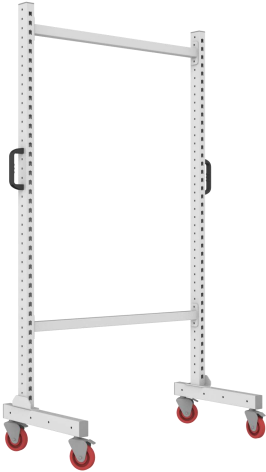

ART NO	DESCRIPTION	DIM	FINISH	LOAD CAPACITY
UF-SF-W	SF UniFlex system with OD-100mm PU wheels	W1000 D535 H1835	RAL 7035	150 KG
UF-SF-E	SF UniFlex system without wheels	W1000 D535 H1710	RAL 7035	150 KG



ART NO	DESCRIPTION	DIM	FINISH	LOAD CAPACITY
UF-DF-W	DF UniFlex system with OD-100mm PU wheels	W1000 D810 H1835	RAL 7035	300 kg (150 kg /side)
UF-DF-E	DF UniFlex system without wheels	W1000 D810 H1710	RAL 7035	300 kg (150 kg /side)



ART NO	DESCRIPTION	DIM	FINISH	LOAD CAPACITY
UF-SF-BT	UniFlex Bottom tray—Single face	W920 D405 H45	RAL 7035	20 KG



ART NO	DESCRIPTION	DIM	FINISH	LOAD CAPACITY
UF-DF-BT	UniFlex Bottom tray—Double face	W920 D800 H45	RAL 7035	20 KG



All indicated loads are net and refer to evenly distributed weights

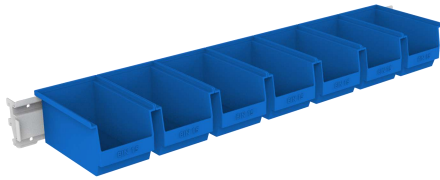

Height adjustable & Tilttable Bin rail in 2 positions

ART NO	DESCRIPTION	DIM	FINISH	LOAD CAPACITY
UF-BR	UniFlex Bin rail (Without Bin)	L970	RAL 7035	20 kg



Fixed shelf 165mm - Height adjustable

ART NO	DESCRIPTION	DIM	FINISH	LOAD CAPACITY
UF-FX165	Fixed shelf D165	L955	RAL 7035	20 kg



Fixed shelf 225mm - Height adjustable

ART NO	DESCRIPTION	DIM	FINISH	LOAD CAPACITY
UF-FX225	Fixed shelf D225	L955	RAL 7035	20 kg



Tilttable shelf 225mm - Height adjustable

ART NO	DESCRIPTION	DIM	FINISH	LOAD CAPACITY
UF-TSH225	Tilttable shelf D225	L950	RAL 7035	25 kg

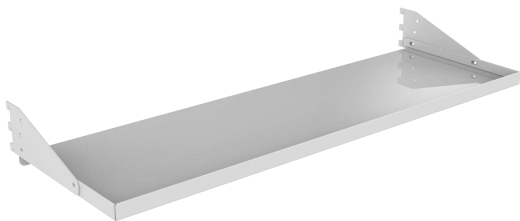

Tilttable shelf 325mm - Height adjustable

ART NO	DESCRIPTION	DIM	FINISH	LOAD CAPACITY
UF-TSH325	Tilttable shelf D325	L950	RAL 7035	25 kg

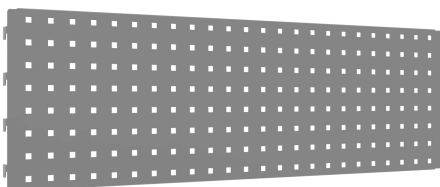

Perforated panel - Height adjustable

ART NO	DESCRIPTION	DIM	FINISH	LOAD CAPACITY
UF-PF	Perforated panel	L950 H304	RAL 7037	20 kg



All indicated loads are net and refer to evenly distributed weights

NC SYSTEMS

hyna



TOOL HOLDERS

- Made of ABS, resistant to impact and mineral oils.
- They are fixed to the frame with screws to improve stability during spindle handling.

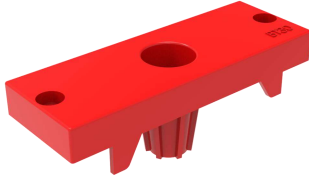

ART NO	DIMENSION	CONE SIZE	COLOUR
BT 30	140 x 50 x 50H mm	Top - $\varnothing 32.5$, Bottom - $\varnothing 19$	Red

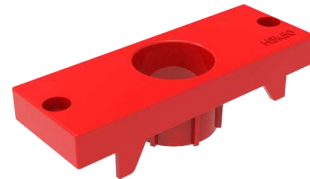

ART NO	DIMENSION	CONE SIZE	COLOUR
HSK 50	140 x 50 x 26H mm	Top - $\varnothing 37.5$, Bottom - $\varnothing 36$	Red

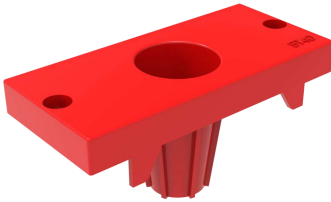

ART NO	DIMENSION	CONE SIZE	COLOUR
BT 40	140 x 65 x 65H mm	Top - $\varnothing 45$, Bottom - $\varnothing 27$	Red

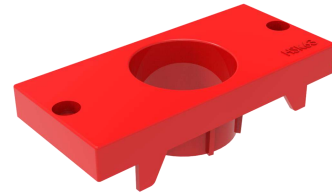

ART NO	DIMENSION	CONE SIZE	COLOUR
HSK 63	140 x 65 x 34H mm	Top - $\varnothing 48$, Bottom - $\varnothing 46$	Red

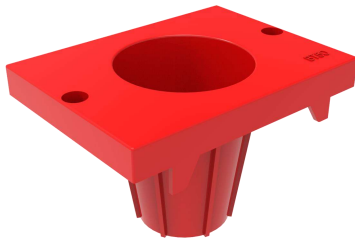

ART NO	DIMENSION	CONE SIZE	COLOUR
BT 50	140 x 104 x 92H mm	Top - $\varnothing 70$, Bottom - $\varnothing 46$	Red

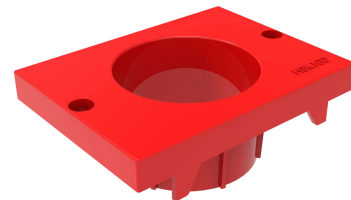

ART NO	DIMENSION	CONE SIZE	COLOUR
HSK 100	140 x 104 x 49H mm	Top - $\varnothing 75$, Bottom - $\varnothing 72$	Red

TOOL HOLDER CABINET



NC-LD-E

W900 D400 H1925 mm
ART. NC-R2 2 Row Carrier - 4 Nos
 Tool holders not included
 90kg UDL / Level



NC-LD-S

W900 D400 H1925 mm
ART. NC-R2 2 Row Carrier - 4 Nos
 Tool holders not included
 90kg UDL / Level



NC-LD-G

W900 D400 H1925 mm
ART. NC-R2 2 Row Carrier - 4 Nos
 Tool holders not included
 90kg UDL / Level

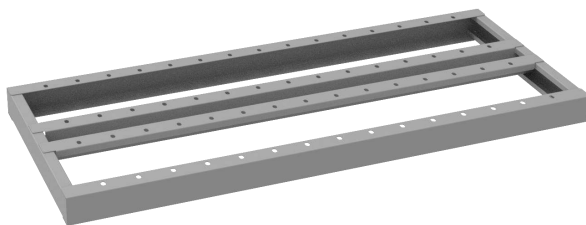

Art No: NC-R2

W895 D358 H50 mm
 Load capacity - 90 Kg UDL

Tool holder type	Qty of Tool holder per frame
BT 30	30 Nos
BT 40	20 Nos
BT 50	14 Nos
HSK 50	30 Nos
HSK 63	20 Nos
HSK 100	14 Nos



All indicated loads are net and refer to evenly distributed weights

TOOL CARRIER

The tool carriers are fully welded and comes with height adjustable supports. The lateral and central supports that make up the rows are polished and allow the sleeves to be positioned at any point on the frame

Art No: NC-R1

W645 D163 H195 mm

Load capacity - 50 Kg

Tool holder type	Qty of Tool holder per frame
BT 30	10 Nos
BT 40	7 Nos
BT 50	5 Nos
HSK 50	10 Nos
HSK 63	7 Nos
HSK 100	5 Nos

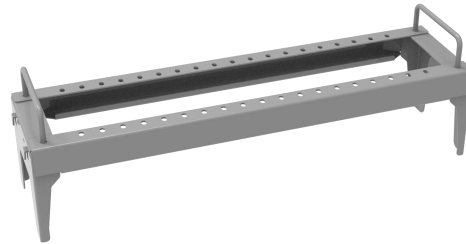

Art No: NC-R3

W640 D465 H52 mm

Load capacity - 150 Kg

Tool holder type	Qty of Tool holder per frame
BT 30	30 Nos
BT 40	21 Nos
BT 50	15 Nos
HSK 50	30 Nos
HSK 63	21 Nos
HSK 100	15 Nos

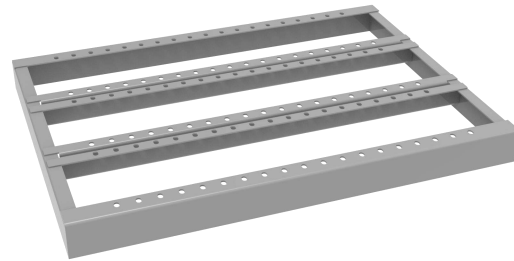

All indicated loads are net and refer to evenly distributed weights



NC-TOWER



NC-TW-01

W760 D520 H1950 mm

ART. NC-R3 3 Row Carrier - 4 Nos
Tool holders not included



NC-TW-02

W760 D520 H1950 mm

ART. NC-R1 1 Row Carrier - 8 Nos
Tool holders not included



NC-TW-03

W760 D520 H1950 mm

ART. NC-R1 1 Row Carrier - 8 Nos
Tool holders not included

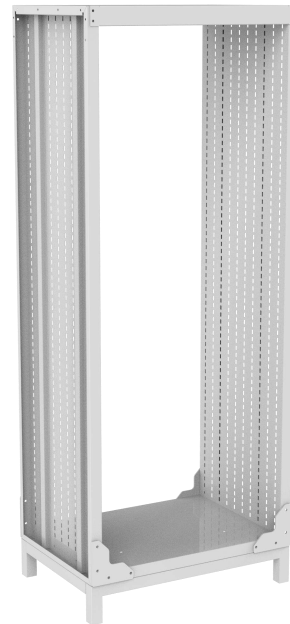

NC-TW-E

W760 D520 H1950 mm

NC Tower frame
Tool holders and carriers should be ordered separately

NC TROLLEY - HEAVY DUTY



NC-TR-01

W1160 D530 H1000 mm

ART. NC-R3 3 Row Carrier - 1 No

ART. NC-R1 1 Row Carrier - 4 Nos

Tool holders not included



NC-TR-02

W1160 D530 H1000 mm

ART. NC-R3 3 Row Carrier - 1 No

ART. NC-R1 1 Row Carrier - 2 Nos

Tool holders not included



NC-TR-03

W1160 D530 H1000 mm

ART. NC-R3 3 Row Carrier - 1 No

Tool holders not included



NC-TR-A1

W860 D530 H1000 mm

Tool holders not included



NC-TR-A2

W300 D530 H120 mm

Effective Ht. 25mm

NC TROLLEY - LIGHT DUTY



ART NO	DIMENSION	CONE SIZE
BT 30 - R	OD62 X H40 mm	Top - \varnothing 32, Bottom - \varnothing 22



ART NO	DIMENSION	ID SIZE
HSK 50 - R	OD68 X H30 mm	ID 37mm



ART NO	DIMENSION	CONE SIZE
BT 40 - R	OD80 X H52 mm	Top - \varnothing 46, Bottom - \varnothing 31



ART NO	DIMENSION	ID SIZE
HSK 63 - R	OD80 X H36 mm	ID 46mm



NC-3050
 W572 D350 H725 mm
 No of tool holder slot: 40
 Tool holders not included

Can be used with
ART No: BT 30-R
ART No: HSK 50-R



NC-4063
 W572 D350 H725 mm
 No of tool holder slot: 30
 Tool holders not included

Can be used with
ART No: BT 40-R
ART No: HSK 63-R

hyna

HEXA WORKBENCH



Hexa Workbench

The space saving hexagonal workbenches are ideal as group workstation and training stations.

The large worktop has sub-structured with 6 drawer units



ART NO: WB HEXA

Cabinet—6 Units

- Size: 577W x 600D x 800H mm
- Rigid welded construction
- 5 drawers with 30 kg load capacity
- Combi locking system with 2 keys for each cabinets

Work top

- 40 | 50 mm MDF Board with high moisture resistance quality
- BSL with cherry and white finish
- Edges are finely closed PVC tape

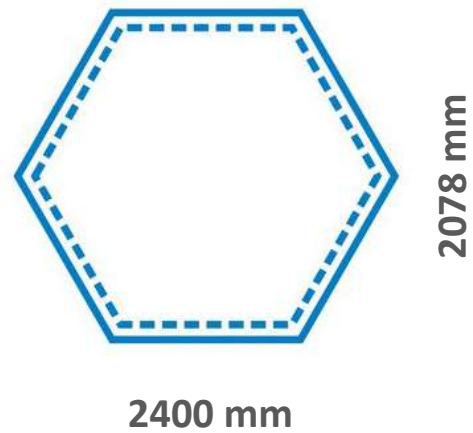

hyna

OFFICE CUPBOARDS

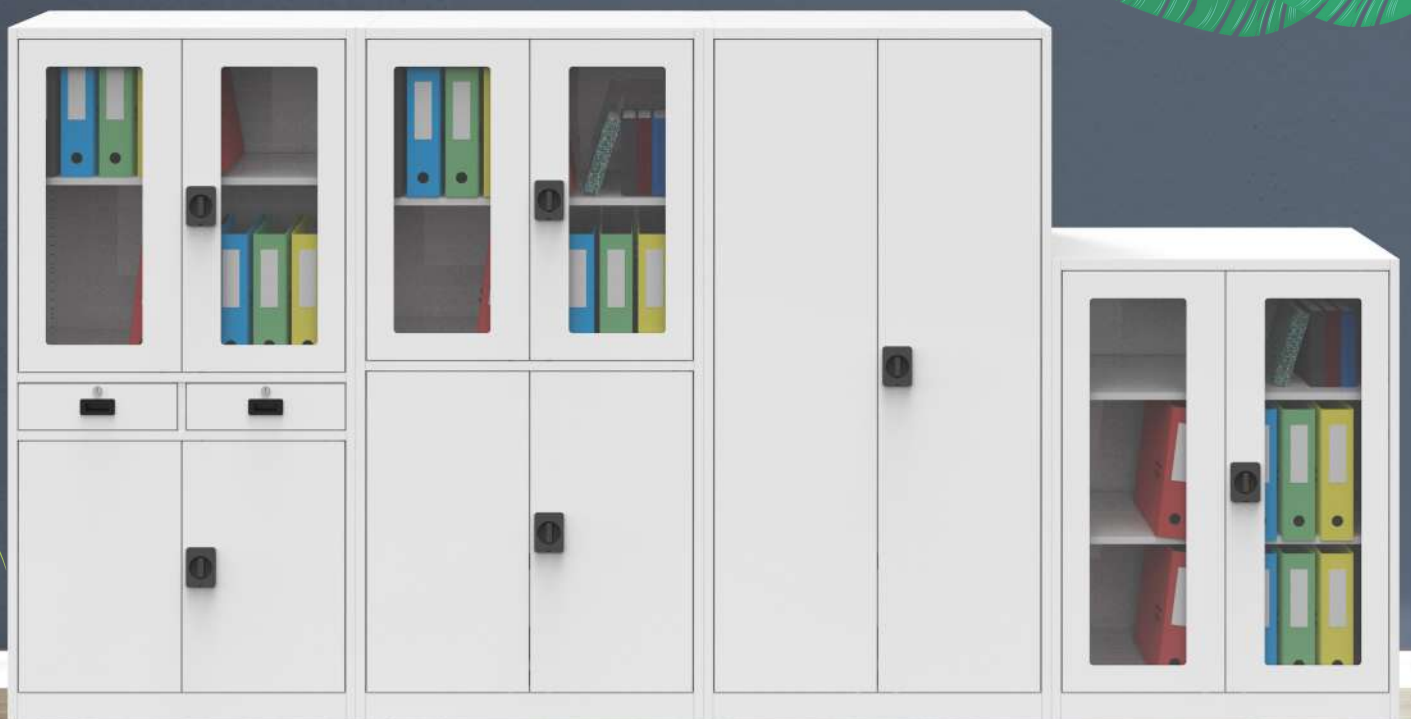



HC-2D Cupboard
H1800*W900*D400

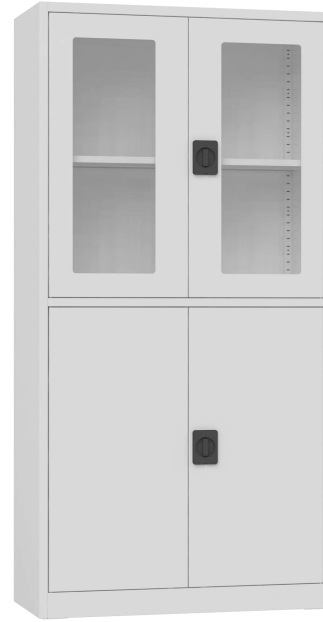

HC-2C Cupboard
H1800*W900*D400



HC-2CG Cupboard
H1800*W900*D400



HC-2CS Cupboard
H1800*W900*D400



HC-G18 Cupboard
H1800*W900*D400

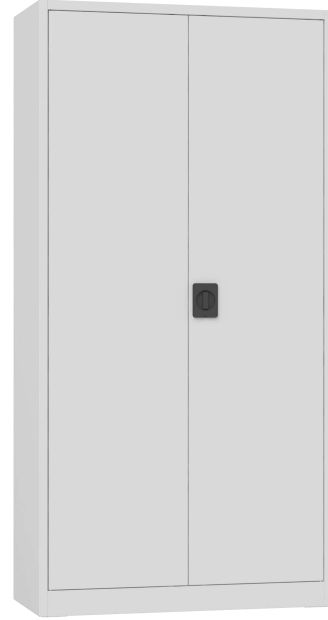

HC-S18 Cupboard
H1800*W900*D400



HC-G12 Cupboard
H1200*W900*D400

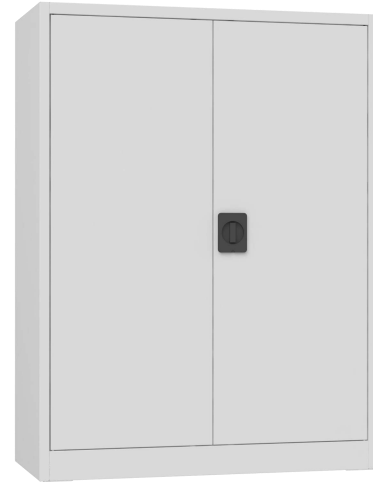

HC-S12 Cupboard
H1200*W900*D400



SL-G18 Cupboard
H1800*W900*D400



SL-S18 Cupboard
H1800*W900*D400



SL-G12 Cupboard
H1200*W900*D400



SL-S12 Cupboard
H1200*W900*D400



HC-G09 Cupboard
H900*W900*D400

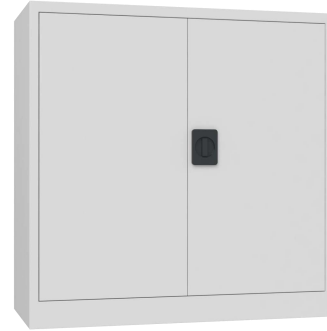

HC-S09 Cupboard
H900*W900*D400



SL-G09 Cupboard
H900*W900*D400



SL-S09 Cupboard
H900*W900*D400

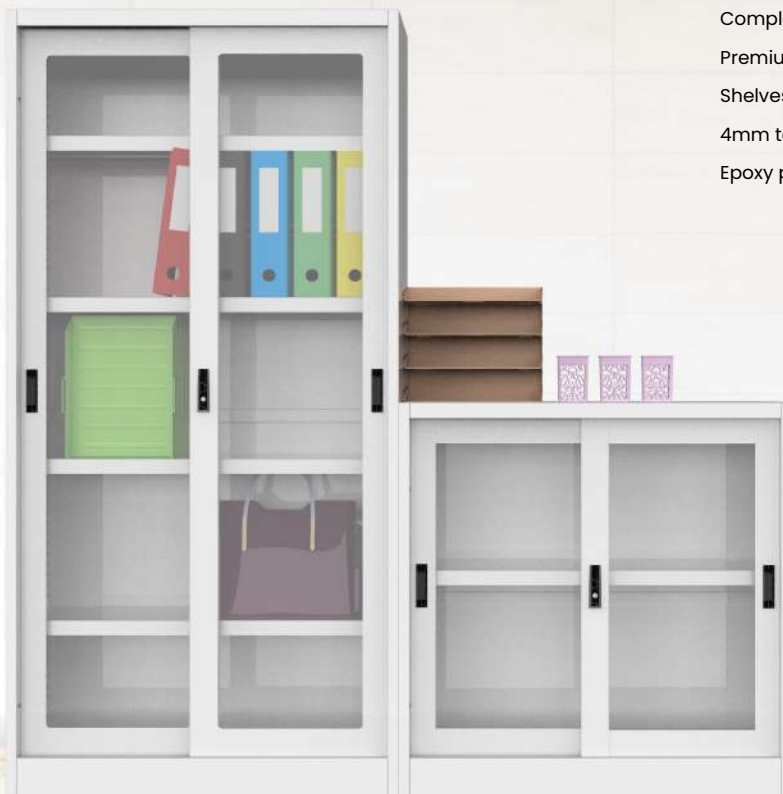

Specification

0.7mm CRCA formed sheet metal construction

Completely knock down design

Premium locks with 2 keys

Shelves load capacity : 50 kg UDL

4mm toughened glasses used in door

Epoxy polyester powder coated finish

hyna

STAFF LOCKERS



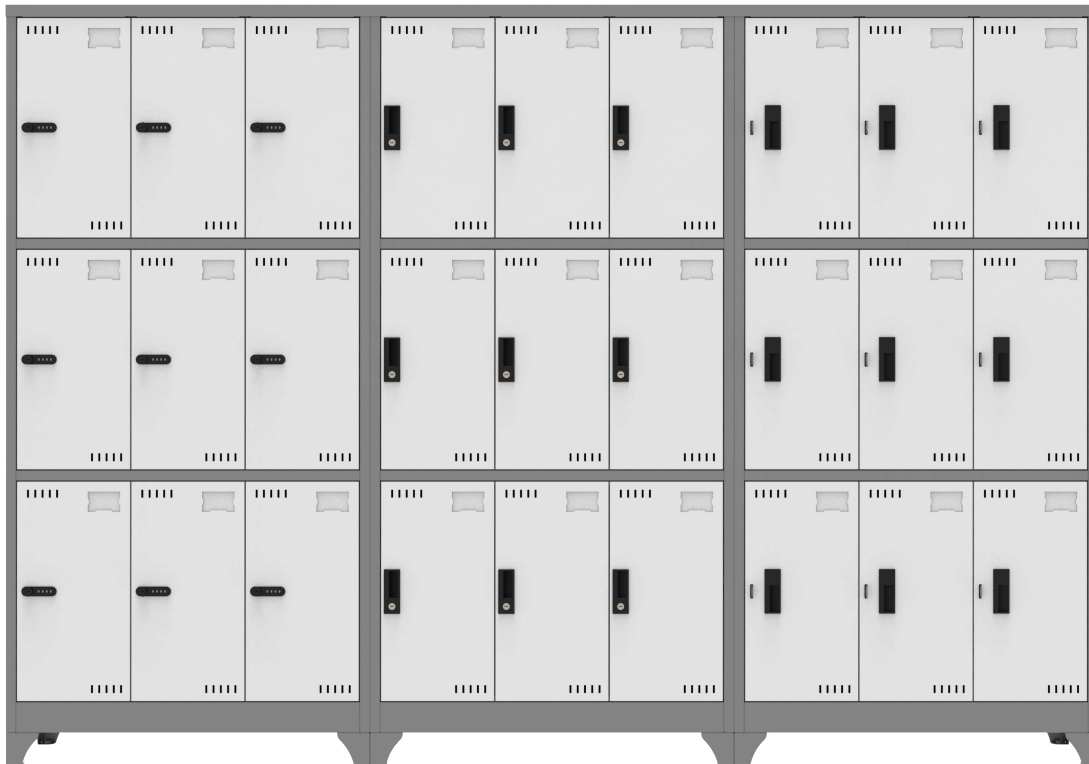

**Numerical lock type
(4 Digit)**

**Cam Lock type
(5000 Combinations)**

**Pad lockable type
(Lock Customer scope)**

1. Sloping roof



A.



B.

HYNA Personal lockers can be supplied with a Flat roof (A) or a Sloping roof (B). The sloping roof easier to clean and is recommended in environments with very demanding hygiene requirements

2. Lock



A.



B.



C.

A - Numerical 4 digit combination lock
 B - Cylindrical cam lock cum handle supplied with 2 keys
 C- Pad lockable door knob (lock not included)

3. Stand feet



Hanger pipe



Mid Shelf

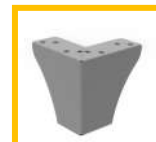

Stand feet
Sold separately

TECHNICAL SPECIFICATION

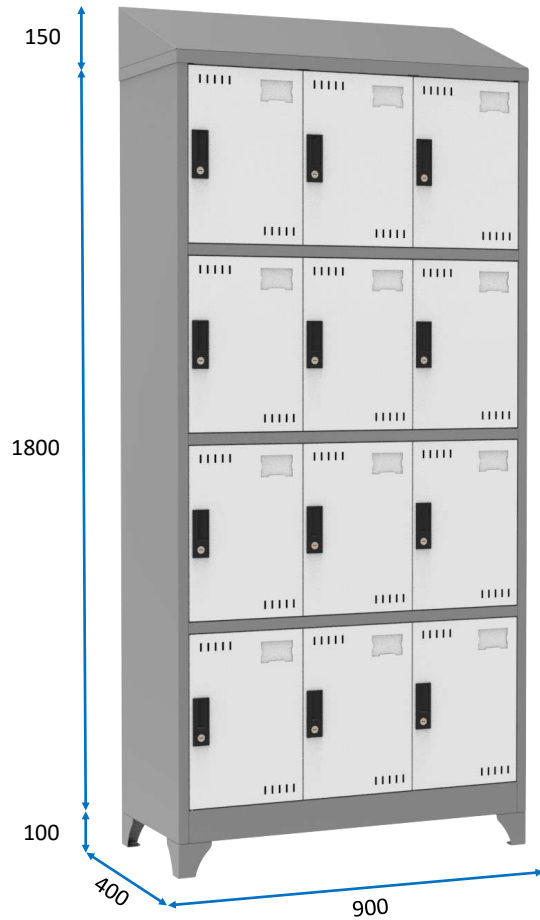

Si no	Parameter	Specification
1	Material	CRCA 0.7mm thickness
2	Construction	Rigid knockdown construction
3	No of doors	3, 6, 9, 12, 15 and 18 Doors available
4	Shelf	Uniformly distributed load capacity per each shelf is 35kg maximum
5	Finish	Epoxy polyester powder coated to the thickness of 70 microns (+/- 10)
6	Handle	Snap fit ABS plastic handle (Only for pad lockable door)
7	Name card holder	Formed on door
8	Ventilation	Attractive punched pattern for air circulation

3 DOOR LOCKER



INTERNAL USABLE SPACE

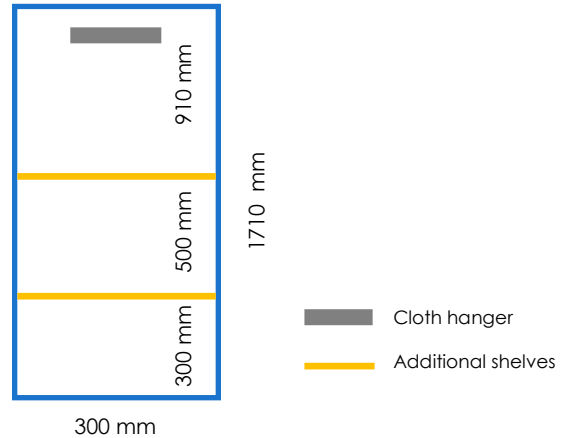

ART NO	DIM	NO OF DOORS	DOOR SIZE	LOCK TYBE
LC-P-3	900x400x1800 H	3 DOORS	W280 H1690	PAD LOCKABLE
LC-C-3	900x400x1800 H	3 DOORS	W280 H1690	CAM LOCK
LC-N-3	900x400x1800 H	3 DOORS	W280 H1690	NUMERICAL LOCK

* Pad lock is customer / user scope

6 DOOR LOCKER



INTERNAL USABLE SPACE

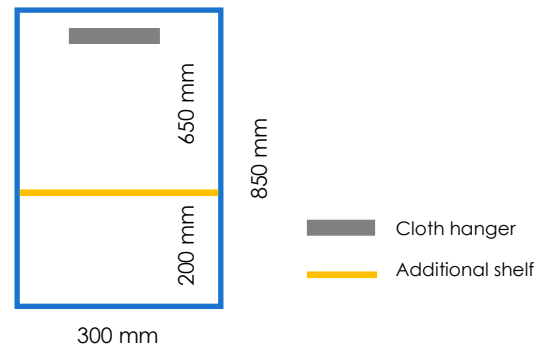

ART NO	DIM	NO OF DOORS	DOOR SIZE	LOCK TYBE
LC-P-6	900x400x1800 H	6 DOORS	W280 H830	PAD LOCKABLE
LC-C-6	900x400x1800 H	6 DOORS	W280 H830	CAM LOCK
LC-N-6	900x400x1800 H	6 DOORS	W280 H830	NUMERICAL LOCK

* Pad lock is customer / user scope

9 DOOR LOCKER



INTERNAL USABLE SPACE

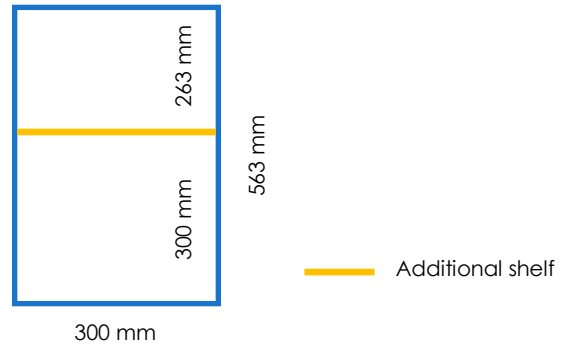

ART NO	DIM	NO OF DOOR	DOOR SIZE	LOCK TYBE
LC-P-9	900x400x1800 H	9 DOORS	W280 H543	PAD LOCKABLE
LC-C-9	900x400x1800 H	9 DOORS	W280 H543	CAM LOCK
LC-N-9	900x400x1800 H	9 DOORS	W280 H543	NUMERICAL LOCK

* Pad lock is customer / user scope

12 DOOR LOCKER

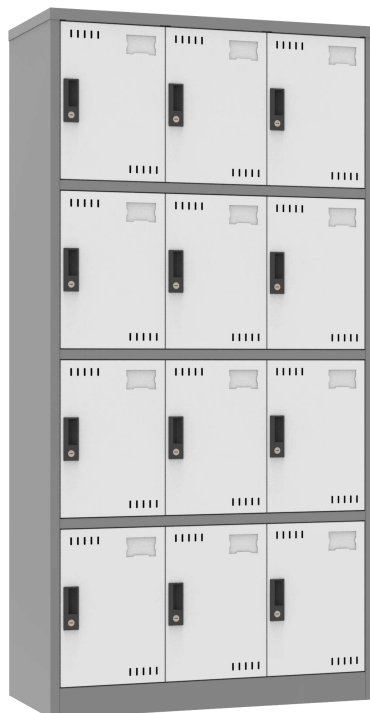

INTERNAL USABLE SPACE

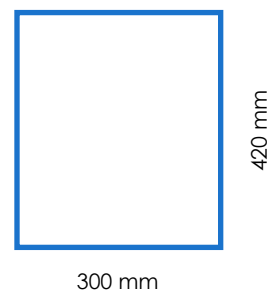

ART NO	DIM	NO OF DOORS	DOOR SIZE	LOCK TYBE
LC-P-12	900x400x1800 H	12 DOORS	W280 H400	PAD LOCKABLE
LC-C-12	900x400x1800 H	12 DOORS	W280 H400	CAM LOCK
LC-N-12	900x400x1800 H	12 DOORS	W280 H400	NUMERICAL LOCK

* Pad lock is customer / user scope

15 DOOR LOCKER

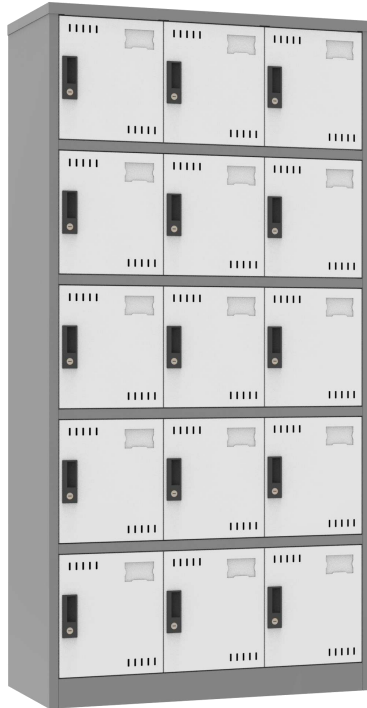

INTERNAL USABLE SPACE

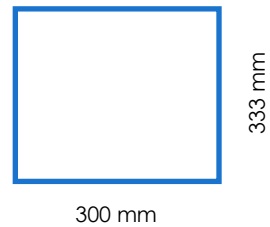

ART NO	DIM	NO OF DOORS	DOOR SIZE	LOCK TYBE
LC-P-15	900x400x1800 H	15 DOORS	W280 H314	PAD LOCKABLE
LC-C-15	900x400x1800 H	15 DOORS	W280 H314	CAM LOCK
LC-N-15	900x400x1800 H	15 DOORS	W280 H314	NUMERICAL LOCK

* Pad lock is customer / user scope

18 DOOR LOCKER

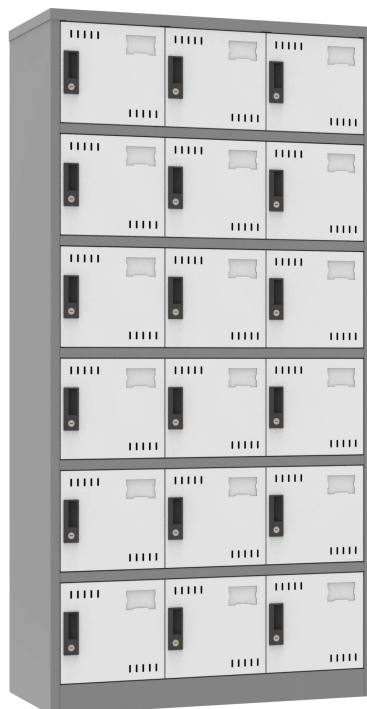

INTERNAL USABLE SPACE

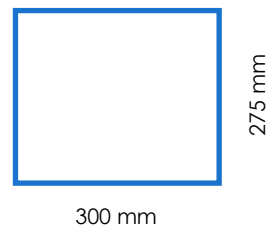

ART NO	DIM	NO OF DOOR	DOOR SIZE	LOCK TYBE
LC-P-18	900x400x1800 H	18 DOORS	W280 H257	PAD LOCKABLE
LC-C-18	900x400x1800 H	18 DOORS	W280 H257	CAM LOCK
LC-N-18	900x400x1800 H	18 DOORS	W280 H257	NUMERICAL LOCK

* Pad lock is customer / user scope

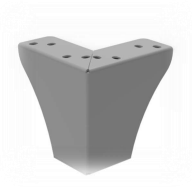

ART NO	DESCRIPTION	DIMENSION
LC-A1	FOOT CLAMP	100mm (Including plastic adjustment)



ART NO	DESCRIPTION	DIMENSION
LC-A2	SLOPING ROOF	W905 D400 H150 mm

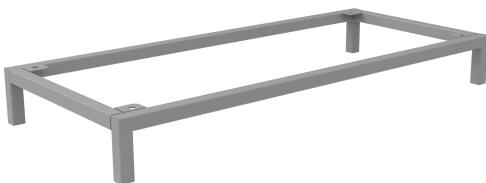

ART NO	DESCRIPTION	DIMENSION
LC-A3	LOCKER STAND	W902 D400 H125 mm (Including plastic adjustment leveler)



ART NO	DESCRIPTION	DIMENSION
LC-A4	LOCKER STAND WITH SEATER	W902 D780 H380 mm (Including plastic adjustment leveler)

**Library shelving**

Widely used in libraries, archives of enterprises

0.7mm Cold rolled steel formed sheet, higher loading capacity, more durable

Comes with wooden side boards or Wooden finish steel side panels

Steel single column design, knock down

Can be customized

hyna

Workspace, Storage & Office Furniture 6.0

Plant 1 & Head office:

KGR FABTEK
No.92/1 Samuel nagar
Vadaperumbakkam, Madhavaram
Pin-6000060, Tamil Nadu
India

Plant 2:

KGR FABTEK
No 230 & 231
Sidco women's industrial park,Thirumullaivoyal
Pin-6000062, Tamil Nadu
India

hynaindia@gmail.com
www.hynaindia.com